

Introduction to Verilog

Table of Contents

1. Introduction	1
2. Lexical Tokens	2
White Space, Comments, Numbers, Identifiers, Operators, Verilog Keywords	
3. Gate-Level Modelling	3
Basic Gates, buf, not Gates, Three-State Gates; buff1, buff0, notif1, notif0	
4. Data Types	4
Value Set, Wire, Reg, Input, Output, Inout	
Integer, Supply0, Supply1	
Time, Parameter	
5. Operators	6
Arithmetic Operators, Relational Operators, Bit-wise Operators, Logical Operators	
Reduction Operators, Shift Operators, Concatenation Operator,	
Conditional Operator: “?” Operator Precedence	
6. Operands	9
Literals, Wires, Regs, and Parameters, Bit-Selects “x[3]” and Part-Selects “x[5:3]”	
Function Calls	
7. Modules	10
Module Declaration, Continuous Assignment, Module Instantiations,	
Parameterized Modules	
8. Behavioral Modeling	12
Procedural Assignments, Delay in Assignment, Blocking and Nonblocking Assignments	
begin ... end, for Loops, while Loops, forever Loops, repeat,	
disable, if ... else if ... else	
case, casex, casez	
9. Timing Controls	17
Delay Control, Event Control, @, Wait Statement, Intra-Assignment Delay	
10. Procedures: Always and Initial Blocks	18
Always Block, Initial Block	
11. Functions	19
Function Declaration, Function Return Value, Function Call, Function Rules, Example	
12. Tasks	21
13. Component Inference	22
Registers, Latches, Flip-flops, Counters, Multiplexers, Adders/Subtractors, Tri-State Buffers	
Other Component Inferences	
14. Finite State Machines	24
Counters, Shift Registers	
15. Compiler Directives	26
Time Scale, Macro Definitions, Include Directive	
16. System Tasks and Functions	27
\$display, \$strobe, \$monitor; \$time, \$stime, \$realttime; \$reset, \$stop, \$finish; \$deposit; \$scope, \$showscope;	
\$list; \$random; \$dumpfile, \$dumpvar, \$dumpon, \$dumpoff, \$dumpall; \$shm_probe, \$shm_open, \$fopen,	
\$fdisplay, \$fstrobe, \$fmonitor.	
17. Test Benches	30
Test Benches, Synchronous Test Benches	
18. Memories	32
Two-dimensional arrays, Initializing memory from a file.	

1. Introduction

Verilog HDL is one of the two most common Hardware Description Languages (HDL) used by integrated circuit (IC) designers. The other one is VHDL.

HDL's allows the design to be simulated earlier in the design cycle in order to correct errors or experiment with different architectures. Designs described in HDL are technology-independent, easy to design and debug, and are usually more readable than schematics, particularly for large circuits.

Verilog can be used to describe designs at four levels of abstraction:

- (i) Algorithmic level (much like c code with if, case and loop statements).
- (ii) Register transfer level (RTL uses registers connected by Boolean equations).
- (iii) Gate level (interconnected AND, NOR etc.).
- (iv) Switch level (the switches are MOS transistors inside gates).

The language also defines constructs that can be used to control the input and output of simulation.

More recently Verilog is used as an input for synthesis programs which will generate a gate-level description (a netlist) for the circuit. Some Verilog constructs are not synthesizable. Also the way the code is written will greatly effect the size and speed of the synthesized circuit. Most readers will want to synthesize their circuits, so nonsynthesizable constructs should be used only for *test benches*. These are program modules used to generate I/O needed to simulate the rest of the design. The words "not synthesizable" will be used for examples and constructs as needed that do not synthesize.

There are two types of code in most HDLs:

Structural, which is a verbal wiring diagram without storage.

```
assign a=b & c | d;    /* “|” is a OR */
assign d = e & (~c);
```

Here the order of the statements does not matter. Changing e will change a.

Procedural which is used for circuits with storage, or as a convenient way to write conditional logic.

```
always @(posedge clk) // Execute the next statement on every rising clock edge.
count <= count+1;
```

Procedural code is written like c code and assumes every assignment is stored in memory until over written. For synthesis, with flip-flop storage, this type of thinking generates too much storage. However people prefer procedural code because it is usually much easier to write, for example, **if** and **case** statements are only allowed in procedural code. As a result, the synthesizers have been constructed which can recognize certain styles of procedural code as actually combinational. They generate a flip-flop only for left-hand variables which truly need to be stored. However if you stray from this style, beware. Your synthesis will start to fill with superfluous latches.

This manual introduces the basic and most common Verilog behavioral and gate-level modelling constructs, as well as Verilog compiler directives and system functions. Full description of the language can be found in *Cadence Verilog-XL Reference Manual* and *Synopsys HDL Compiler for Verilog Reference Manual*. The latter emphasizes only those Verilog constructs that are supported for synthesis by the *Synopsys Design Compiler* synthesis tool.

In all examples, Verilog keyword are shown in **boldface**. Comments are shown in *italics*.

2. Lexical Tokens

Verilog source text files consists of the following lexical tokens:

2.1. White Space

White spaces separate words and can contain spaces, tabs, new-lines and form feeds. Thus a statement can extend over multiple lines without special continuation characters.

2.2. Comments

Comments can be specified in two ways (exactly the same way as in C/C++):

- Begin the comment with double slashes (`//`). All text between these characters and the end of the line will be ignored by the Verilog compiler.
- Enclose comments between the characters `/*` and `*/`. Using this method allows you to continue comments on more than one line. This is good for “commenting out” many lines code, or for very brief in-line comments.

Example 2.1

```
a = c + d;           // this is a simple comment
/* however, this comment continues on more
   than one line */
assign y = temp_reg;
assign x=ABC /* plus its compliment*/ + ABC_
```

2.3. Numbers

Number storage is defined as a number of bits, but values can be specified in binary, octal, decimal or hexadecimal (See Sect. 6.1. for details on number notation).

Examples are `3'b001`, a 3-bit number, `5'd30`, (`=5'b11110`), and `16'h5ED4`, (`=16'd24276`)

2.4. Identifiers

Identifiers are user-defined words for variables, function names, module names, block names and instance names. Identifiers begin with a letter or underscore (Not with a number or \$) and can include any number of letters, digits and underscores. Identifiers in Verilog are case-sensitive.

Syntax

allowed symbols

ABCDE . . . abcdef. . . 1234567890 _\$

not allowed: anything else especially

- & # @

Example 2.2

```
adder           // use underscores to make your
by_8_shifter   // identifiers more meaningful
_ABC_         /* is not the same as */ _abc_
Read_         // is often used for NOT Read
```

2.5. Operators

Operators are one, two and sometimes three characters used to perform operations on variables.

Examples include `>`, `+`, `~`, `&`, `!=`. Operators are described in detail in “Operators” on p. 6.

2.6. Verilog Keywords

These are words that have special meaning in Verilog. Some examples are **assign**, **case**, **while**, **wire**, **reg**, **and**, **or**, **nand**, and **module**. They should not be used as identifiers. Refer to *Cadence Verilog-XL Reference Manual* for a complete listing of Verilog keywords. A number of them will be introduced in this manual. Verilog keywords also includes Compiler Directives (Sect. 15.) and System Tasks and Functions (Sect. 16.).

3. Gate-Level Modelling

Primitive logic gates are part of the Verilog language. Two properties can be specified, *drive_strength* and *delay*.

Drive_strength specifies the strength at the gate outputs. The strongest output is a direct connection to a source, next comes a connection through a conducting transistor, then a resistive pull-up/down. The drive strength is usually not specified, in which case the strengths defaults to **strong1** and **strong0**. Refer to *Cadence Verilog-XL Reference Manual* for more details on strengths.

Delays: If no delay is specified, then the gate has no propagation delay; if two delays are specified, the first represent the rise delay, the second the fall delay; if only one delay is specified, then rise and fall are equal. Delays are ignored in synthesis. This method of specifying delay is a special case of “Parameterized Modules” on page 11. The parameters for the primitive gates have been predefined as delays.

3.1. Basic Gates

These implement the basic logic gates. They have one output and one or more inputs. In the gate instantiation syntax shown below, GATE stands for one of the keywords **and**, **nand**, **or**, **nor**, **xor**, **xnor**.

Syntax

```
GATE (drive_strength) # (delays)
instance_name1(output, input_1,
                input_2,..., input_N),
instance_name2(outp,in1, in2,..., inN);
Delays is
    #(rise, fall) or
    # rise_and_fall or
    #(rise_and_fall)
```

Example 3.1

```
and c1 (o, a, b, c, d); // 4-input AND called c1 and
                    c2 (p, f g); // a 2-input AND called c2.
or #(4, 3) ig (o, a, b); /* or gate called ig (instance name);
                        rise time = 4, fall time = 3 */
xor #(5) xor1 (a, b, c); // a = b XOR c after 5 time units
xor (pull1, strong0) #5 (a,b,c); /* Identical gate with pull-up
                                strength pull1 and pull-down strength strong0. */
```

3.2. buf, not Gates

These implement buffers and inverters, respectively. They have one input and one or more outputs. In the gate instantiation syntax shown below, GATE stands for either the keyword **buf** or **not**

Syntax

```
GATE (drive_strength) # (delays)
instance_name1(output_1, output_2,
                ..., output_n, input),
instance_name2(out1, out2, ..., outN, in);
```

Example 3.2

```
not #(5) not_1 (a, c); // a = NOT c after 5 time units
buf c1 (o, p, q, r, in); // 5-output and 2-output buffers
                    c2 (p, f g);
```

3.3. Three-State Gates; bufif1, bufif0, notif1, notif0

These implement 3-state buffers and inverters. They propagate z (3-state or high-impedance) if their control signal is deasserted. These can have three delay specifications: a rise time, a fall time, and a time to go into 3-state.

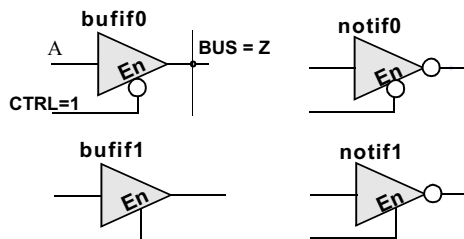

Example 3.3

```
bufif0 #(5) not_1 (BUS, A, CTRL); /* BUS = A
                                5 time units after CTRL goes low. */
notif1 #(3,4,6) c1 (bus, a, b, cntr); /* bus goes tri-state
                                6 time units after ctrl goes low. */
```

4. Data Types

4.1. Value Set

Verilog consists of only four basic values. Almost all Verilog data types store all these values:

- 0** (logic zero, or false condition)
- 1** (logic one, or true condition)
- x** (unknown logic value) x and z have limited use for synthesis.
- z** (high impedance state)

4.2. Wire

A **wire** represents a physical wire in a circuit and is used to connect gates or modules. The value of a **wire** can be read, but not assigned to, in a function or block. See “Functions” on p. 19, and “Procedures: Always and Initial Blocks” on p. 18. A **wire** does not store its value but must be driven by a continuous assignment statement or by connecting it to the output of a gate or module. Other specific types of wires include:

- wand** (wired-AND);: the value of a wand depend on logical AND of all the drivers connected to it.
- wor** (wired-OR);: the value of a wor depend on logical OR of all the drivers connected to it.
- tri** (three-state);: all drivers connected to a tri must be z, except one (which determines the value of the tri).

Syntax

```
wire [msb:lsb] wire_variable_list;
wand [msb:lsb] wand_variable_list;
wor [msb:lsb] wor_variable_list;
tri [msb:lsb] tri_variable_list;
```

Example 4.1

```
wire c           // simple wire
wand d;
assign d = a;    // value of d is the logical AND of
assign d = b;    // a and b
wire [9:0] A;    // a cable (vector) of 10 wires.
```

4.3. Reg

Declare type **reg** for all data objects on the left hand side of expressions in **initial** and **always** procedures, or **functions**. See “Procedural Assignments” on page 12. A **reg** is the data type that must be used for latches, flip-flops and memories. However it often synthesizes into leads rather than storage. In multi-bit registers, data is stored as *unsigned* numbers and no sign extension is done for what the user might have thought were two’s complement numbers.

Syntax

```
reg [msb:lsb] reg_variable_list;
```

Example 4.2

```
reg a;           // single 1-bit register variable
reg [7:0] tom;   // an 8-bit vector; a bank of 8 registers.
reg [5:0] b, c;  // two 6-bit variables
```

4.4. Input, Output, Inout

These keywords declare input, output and bidirectional ports of a **module** or **task**. Input and inout ports are of type **wire**. An output port can be configured to be of type **wire**, **reg**, **wand**, **wor** or **tri**. The default is **wire**.

Syntax

```
input [msb:lsb] input_port_list;
output [msb:lsb] output_port_list;
inout [msb:lsb] inout_port_list;
```

Example 4.3

```
module sample(b, e, c, a); //See “Module Instantiations” on p. 10
  input a;                // An input which defaults to wire.
  output b, e;           // Two outputs which default to wire
  output [1:0] c;        /* A two-bit output. One must declare its
                          type in a separate statement. */
  reg [1:0] c;           // The above c port is declared as reg.
```

4.5. Integer

Integers are general-purpose variables. For synthesis they are used mainly loops-indices, parameters, and constants. See “Parameter” on p. 5. They are of implicitly of type **reg**. However they store data as signed numbers whereas explicitly declared **reg** types store them as unsigned. If they hold numbers which are not defined at compile time, their size will default to 32-bits. If they hold constants, the synthesizer adjusts them to the minimum width needed at compilation.

Syntax

```
integer integer_variable_list;
... integer_constant ... ;
```

Example 4.4

```
integer a;           // single 32-bit integer
assign b=63;        // 63 defaults to a 7-bit variable.
```

4.6. Supply0, Supply1

Supply0 and **supply1** define wires tied to logic 0 (ground) and logic 1 (power), respectively.

Syntax

```
supply0 logic_0_wires;
supply1 logic_1_wires;
```

Example 4.5

```
supply0 my_gnd;    // equivalent to a wire assigned 0
supply1 a, b;
```

4.7. Time

Time is a 64-bit quantity that can be used in conjunction with the **\$time** system task to hold simulation time. Time is not supported for synthesis and hence is used only for simulation purposes.

Syntax

```
time time_variable_list;
```

Example 4.6

```
time c;
c = $time;           // c = current simulation time
```

4.8. Parameter

Parameters allows constants like word length to be defined symbolically in one place. This makes it easy to change the word length later, by change only the parameter. See also “Parameterized Modules” on page 11 . An alternative way to do the same thing is to use macro substitution, see “Macro Definitions” on page 26.

Syntax

```
parameter par_1 = value,
           par_2 = value, .....,
parameter [range] parm_3 = value
```

Example 4.7

```
parameter add = 2'b00, sub = 3'b111;
parameter n = 4;
parameter [3:0] st4 = 4'b1010;
...
reg [n-1:0] harry; /* A 4-bit register whose length is
                   set by parameter n above. */
always @(x)
  y = {{(add - sub){x}}}; // The replication operator Sect. 5.8.
  if (x) begin
    state = st4[1]; else state = st4[2];
  end
```

5. Operators

5.1. Arithmetic Operators

These perform arithmetic operations. The + and - can be used as either unary (-z) or binary (x-y) operators.

Operators

- + (addition)
- (subtraction)
- * (multiplication)
- / (division)
- % (modulus)

Example 5.1

```
parameter n = 4;
reg[3:0] a, c, f, g, count;
f = a + c;
g = c - n;
count = (count + 1)%16;    //Can count 0 thru 15.
```

5.2. Relational Operators

Relational operators compare two operands and return a single bit 1 or 0. These operators synthesize into comparators. Wire and reg variables are positive Thus (-3'b001) == 3'b111 and (-3d001)>3d110. However for integers -1<6.

Operators

- < (less than)
- <= (less than or equal to)
- > (greater than)
- >= (greater than or equal to)
- == (equal to)
- != (not equal to)

Example 5.2

```
if (x == y) e = 1;
else      e = 0;

// Compare in 2's compliment; a>b
reg [3:0] a,b;
if (a[3]== b[3]) a[2:0] > b[2:0];
else            b[3];
```

Equivalent Statement

```
e = (x == y);
```

5.3. Bit-wise Operators

Bit-wise operators do a bit-by-bit comparison between two operands. However see "Reduction Operators" on p. 7.

Operators

- ~ (bitwise NOT)
- & (bitwise AND)
- | (bitwise OR)
- ^ (bitwise XOR)
- ^^ or ^^~ (bitwise XNOR)

Example 5.3

```
module and2 (a, b, c);
input [1:0] a, b;
output [1:0] c;
assign c = a & b;
endmodule
```

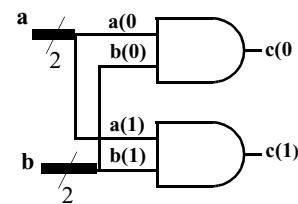

5.4. Logical Operators

Logical operators return a single bit 1 or 0. They are the same as bit-wise operators only for single bit operands. They can work on expressions, integers or groups of bits, and treat all values that are nonzero as "1". Logical operators are typically used in conditional (if ... else) statements since they work with expressions.

Operators

- ! (logical NOT)
- && (logical AND)
- || (logical OR)

Example 5.4

```
wire[7:0] x, y, z;    // x, y and z are multibit variables.
reg a;
...
if ((x == y) && (z)) a = 1; // a = 1 if x equals y, and z is nonzero.
else a = !x;              // a = 0 if x is anything but zero.
```

5.5. Reduction Operators

Reduction operators operate on all the bits of an operand vector and return a single-bit value. These are the unary (one argument) form of the bit-wise operators above.

Operators

& (reduction AND)
 | (reduction OR)
 ~& (reduction NAND)
 ~| (reduction NOR)
 ^ (reduction XOR)
 ~^ or ^~ (reduction XNOR)

Example 5.5

```
module chk_zero (a, z);
  input [2:0] a;
  output z;
  assign z = ~| a; // Reduction NOR
endmodule
```

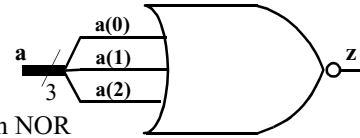

5.6. Shift Operators

Shift operators shift the first operand by the number of bits specified by the second operand. Vacated positions are filled with zeros for both left and right shifts (There is no sign extension).

Operators

<< (shift left)
 >> (shift right)

Example 5.6

```
assign c = a << 2; /* c = a shifted left 2 bits;
                  vacant positions are filled with 0's */
```

5.7. Concatenation Operator

The concatenation operator combines two or more operands to form a larger vector.

Operators

{ } (concatenation)

Example 5.7

```
wire [1:0] a, b; wire [2:0] x; wire [3:0] y, Z;
assign x = {1'b0, a}; // x[2]=0, x[1]=a[1], x[0]=a[0]
assign y = {a, b}; /* y[3]=a[1], y[2]=a[0], y[1]=b[1],
y[0]=b[0] */

assign {cout, y} = x + Z; // Concatenation of a result
```

5.8. Replication Operator

The replication operator makes multiple copies of an item.

Operators

{n{item}} (n fold replication of an item)

Example 5.8

```
wire [1:0] a, b; wire [4:0] x;
assign x = {2{1'b0}, a}; // Equivalent to x = {0,0,a}
assign y = {2{a}, 3{b}}; //Equivalent to y = {a,a,b,b}
```

For synthesis, Synopsis did not like a zero replication. For example:-

```
parameter n=5, m=5;
assign x = {(n-m){a}}
```

5.9. Conditional Operator: “?”

Conditional operator is like those in C/C++. They evaluate one of the two expressions based on a condition. It will synthesize to a multiplexer (MUX).

Operators

(cond) ? (result if cond true):
(result if cond false)

Example 5.9

```
assign a = (g) ? x : y;
assign a = (inc == 2) ? a+1 : a-1;
/* if (inc), a = a+1, else a = a-1 */
```

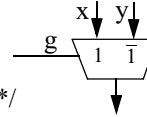

5.10. Operator Precedence

Table 6.1 shows the precedence of operators from highest to lowest. Operators on the same level evaluate from left to right. It is strongly recommended to use parentheses to define order of precedence and improve the readability of your code.

Operator	Name
[]	bit-select or part-select
()	parenthesis
!, ~	logical and bit-wise NOT
&, , ~&, ~ , ^, ~^, ^~	reduction AND, OR, NAND, NOR, XOR, XNOR; If X=3'B101 and Y=3'B110, then X&Y=3'B100, X^Y=3'B011;
+, -	unary (sign) plus, minus; +17, -7
{ }	concatenation; {3'B101, 3'B110} = 6'B101110;
{ { } }	replication; {3{3'B110}} = 9'B110110110
*, /, %	multiply, divide, modulus; <i>/and % not be supported for synthesis</i>
+, -	binary add, subtract.
<<, >>	shift left, shift right; X<<2 is multiply by 4
<, <=, >, >=	comparisons. Reg and wire variables are taken as positive numbers.
==, !=	logical equality, logical inequality
===, !==	case equality, case inequality; <i>not synthesizable</i>
&	bit-wise AND; AND together all the bits in a word
^, ~^, ^~	bit-wise XOR, bit-wise XNOR
	bit-wise OR; AND together all the bits in a word
&&,	logical AND. Treat all variables as False (zero) or True (nonzero).
	logical OR. (7 0) is (T F) = 1, (2 -3) is (T T) = 1, (3&&0) is (T&&F) = 0.
? :	conditional. x=(cond)? T : F;

Table 5.1: Verilog Operators Precedence

6. Operands

6.1. Literals

Literals are constant-valued operands that can be used in Verilog expressions. The two common Verilog literals are:

- (a) String: A string literal is a one-dimensional array of characters enclosed in double quotes (“”).
- (b) Numeric: constant numbers specified in binary, octal, decimal or hexadecimal.

Number Syntax

n’Fddd..., where
 n - integer representing number of bits
 F - one of four possible base formats:
 b (binary), **o** (octal), **d** (decimal),
 h (hexadecimal). Default is **d**.
 dddd - legal digits for the base format

Example 6.1

```
“time is”// string literal
267 // 32-bit decimal number
2’b01 // 2-bit binary
20’hB36F// 20-bit hexadecimal number
’o62 // 32-bit octal number
```

6.2. Wires, Regs, and Parameters

Wires, regs and parameters can also be used as operands in Verilog expressions. These data objects are described in more detail in Sect. 4. .

6.3. Bit-Selects “x[3]” and Part-Selects “x[5:3]”

Bit-selects and part-selects are a selection of a single bit and a group of bits, respectively, from a wire, reg or parameter vector using square brackets “[]”. Bit-selects and part-selects can be used as operands in expressions in much the same way that their parent data objects are used.

Syntax

```
variable_name[index]
variable_name[msb:lsb]
```

Example 6.2

```
reg [7:0] a, b;
reg [3:0] ls;
reg c;
c = a[7] & b[7]; // bit-selects
ls = a[7:4] + b[3:0]; // part-selects
```

6.4. Function Calls

The return value of a function can be used directly in an expression without first assigning it to a register or wire variable. Simply place the function call as one of the operands. Make sure you know the bit width of the return value of the function call. Construction of functions is described in “Functions” on page 19

Syntax

```
function_name (argument_list)
```

Example 6.3

```
assign a = b & c & chk_bc(c, b); // chk_bc is a function
.. /* Definition of the function */
function chk_bc; // function definition
input c,b;
chk_bc = b^c;
endfunction
```

7. Modules

7.1. Module Declaration

A module is the principal design entity in Verilog. The first line of a module declaration specifies the name and port list (arguments). The next few lines specifies the i/o type (**input**, **output** or **inout**, see Sect. 4.4.) and width of each port. The default port width is 1 bit.

Then the port variables must be declared **wire**, **wand**, . . . , **reg** (See Sect. 4.). The default is **wire**. Typically inputs are **wire** since their data is latched outside the module. Outputs are type **reg** if their signals were stored inside an **always** or **initial** block (See Sect. 10.).

Syntax

```

module module_name (port_list);
  input [msb:lsb] input_port_list;
  output [msb:lsb] output_port_list;
  inout [msb:lsb] inout_port_list;
  ... statements ...
endmodule

```

Example 7.1

```

module add_sub(add, in1, in2, oot);
  input add;           // defaults to wire
  input [7:0] in1, in2; wire in1, in2;
  output [7:0] oot; reg oot;
  ... statements ...
endmodule

```

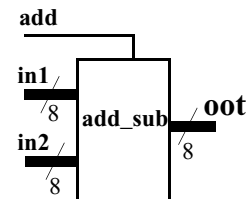

7.2. Continuous Assignment

The continuous assignment is used to assign a value onto a wire in a module. It is the normal assignment outside of **always** or **initial** blocks (See Sect. 10.). Continuous assignment is done with an explicit **assign** statement or by assigning a value to a wire during its declaration. Note that continuous assignment statements are concurrent and are continuously executed during simulation. The order of assign statements does not matter. Any change in any of the right-hand-side inputs will immediately change a left-hand-side output.

Syntax

```

wire wire_variable = value;
assign wire_variable = expression;

```

Example 7.2

```

wire [1:0] a = 2'b01; // assigned on declaration
assign b = c & d;     // using assign statement
assign d = x | y;
/* The order of the assign statements
does not matter. */

```

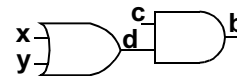

7.3. Module Instantiations

Module declarations are templates from which one creates actual objects (instantiations). Modules are instantiated inside other modules, and each instantiation creates a unique object from the template. The exception is the top-level module which is its own instantiation.

Module Arguments

The instantiated module's ports must be matched to those defined in the template. This is specified:

- (i) by name, using a dot(.) “ .template_port_name (name_of_wire_connected_to_port)”.
- or(ii) by position, placing the ports in exactly the same positions in the port lists of both the template and the instance.

Example 7.3

```

// Passing arguments(signals) by position.
module byposition (wir1, wir2, reg1);
  ...
// Module instance
byname bypositioninstance(x, y ,z);

```

1st 2nd 3rd

Example 7.3

```

// Passing arguments by using port names a, b, c
module byname (a.wir1, b.wir2, c.reg1);
  ...
// Module instance
byname bynameinstance(c.z, a.x, b.y);

```

Syntax for Instantiation

```

module_name
  instance_name_1 (port_connection_list),
  instance_name_2 (port_connection_list),
  .....
  instance_name_n (port_connection_list);

```

Example 7.4

// MODULE DEFINITION

```

module and4(a, b, c);
  input [3:0] a, b;
  output [3:0] c;
  assign c = a & b;
endmodule

```

// MODULE INSTANTIATIONS

```

wire [3:0] in1, in2;
wire [3:0] o1, o2;
/* C1 is an instance of module and4
   C1 ports referenced by position */
and4 C1 (in1, in2, o1);
/* C2 is another instance of and4.
   C2 ports are referenced to the
   declaration by name. */
and4 C2 (.c(o2), .a(in1), .b(in2));

```

Modules may not be instantiated inside procedural blocks. See “Procedures: Always and Initial Blocks” on page 18.

7.4. Parameterized Modules

You can build modules that are parameterized and specify the value of the parameter at each instantiation of the module. See “Parameter” on page 5 for the use of parameters inside a module. Primitive gates have parameters which have been predefined as delays. See “Basic Gates” on page 3.

Syntax

```

module_name #(1st_parameter_values,
  2nd_parm_value, ...)

  instance_name(port_connection_list);

```

Example 7.5

// MODULE DEFINITION

```

module shift_n (it, ot); // used in module test_shift.
  input [7:0] it; output [7:0] ot;
  parameter n = 2; // default value of n is 2
  assign ot = (it << n); // it shifted left n times
endmodule

```

// PARAMETERIZED INSTANTIATIONS

```

wire [7:0] in1, ot1, ot2, ot3;
shift_n shft2(in1, ot1), // shift by 2; default
shift_n #(3) shft3(in1, ot2); // shift by 3; override parameter 2.
shift_n #(5) shft5(in1, ot3); // shift by 5; override parameter 2.

```

Synthesis does not support the **defparam** keyword which is an alternate way of changing parameters.

Syntax

```

defparam instance_name.parameter
  = parameter_value;

module_name instance_name
  (port_connection_list);

```

// PARAMETERIZED INSTANTIATIONS

```

wire [7:0] in1, ot1, ot2, ot3;
defparam shft3.n=3, shft5.n=5;
shift_n shft2(in1, ot1), // shift by 2; default
shift_n shft3(in1, ot2); // shift by 3; override parameter 2.
shift_n shft5(in1, ot3); // shift by 5; override parameter 2.

```

Macros do string substitutions and do many of the jobs parameters do. They are good for global parameters because they do not have to be passed through modules. See Sect. 15.2. for more information.

Syntax

```

`define macro_name
  text_string_to_be_substituted;

```

// USING MACROS LIKE PARAMETERS

```

`define M 8 // Word width
module top
  wire [`M-1:0] x, y, z; // equivalent to wire [8-1:0] x,y,z;

```

8. Behavioral Modeling

Verilog has four levels of modelling:

- 1) The switch level which includes MOS transistors modelled as switches. This is not discussed here.
- 2) The gate level. See “Gate-Level Modelling” on p. 3
- 3) The Data-Flow level using logic equations. See Example 7.4 on page 11
- 4) The Behavioral or procedural level described below.

Verilog procedural statements are used to model a design at a higher level of abstraction than the other levels. They provide powerful ways of doing complex designs. However small changes in coding methods can cause large changes in the hardware generated. Procedural statements can only be used in procedures. Verilog procedures are described later in “Procedures: Always and Initial Blocks” on page 18, “Functions” on page 19, and “Tasks, Not Synthesizable” on page 21.

8.1. Procedural Assignments

Procedural assignments are assignment statements used within Verilog procedures (**always** and **initial** blocks). Only **reg** variables and **integers** (and their bit/part-selects and concatenations) can be placed left of the “=” in procedures. The right hand side of the assignment is an expression which may use any of the operator types described in Sect. 5.

8.2. Delay in Assignment (*not for synthesis*)

In a *delayed assignment* Δt time units pass before the statement is executed and the left-hand assignment is made. With *intra-assignment delay*, the right side is evaluated immediately but there is a delay of Δt before the result is placed in the left hand assignment. If another procedure changes a right-hand side signal during Δt , it does not effect the output. Delays are not supported by synthesis tools.

Syntax for Procedural Assignment

variable = expression

Delayed assignment

Δt variable = expression;

Intra-assignment delay

variable = # Δt expression;

Example 8.1

```
reg [6:0] sum;    reg h, ziltch;
sum[7] = b[7] ^ c[7]; // execute now.
ziltch = #15 ckz&h; /* ckz&a evaluated now; ziltch changed
                    after 15 time units. */
#10 hat = b&c;    /* 10 units after ziltch changes, b&c is
                    evaluated and hat changes. */
```

8.3. Blocking Assignments

Procedural (blocking) assignments (=) are done sequentially in the order the statements are written. A second assignment is not started until the preceding one is complete. See also Sect. 9.4.

Syntax

Blocking

variable = expression;

variable = # Δt expression;

grab inputs now, deliver ans.

later, don't delay next statement

Δt variable = expression;

grab inputs later, deliver ans.

later; delay next statement by # Δt

Example 8.2. For simulation

initial

begin

a=1; b=2; c=3;

#5 a = b + c; // wait for 5 units, and execute a = b + c =5.

d = a; // Time continues from last line, d=5 = b+c at t=5.

Example 8.2. For synthesis

always @(posedge clk)

begin

Z=Y; Y=X; // shift register

y=x; z=y; //parallel ff.

// IN POSEDGE CLK PROCEDURES

//NONBLOCKING FOR SYNTHESIS IS CONFUSING.

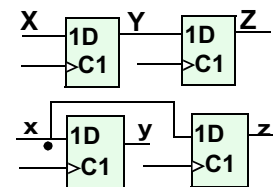

8.4. Nonblocking (RTL) Assignments (*see below for synthesis*)

RTL (nonblocking) assignments (\leq), which follow each other in the code, are started in parallel. The right hand side of nonblocking assignments is evaluated starting from the completion of the last blocking assignment or if none, the start of the procedure.

The transfer to the left hand side is made according to the delays. An intra-assignment delay in a non-blocking statement will not delay the start of any subsequent statement blocking or non-blocking. However normal delays are cumulative and will delay the output.

For synthesis

- One must not mix “ \leq ” or “ $=$ ” in the same procedure.
- “ \leq ” best mimics what physical flip-flops do; use it for “always @ (posedge clk ..) type procedures.
- “ $=$ ” best corresponds to what c/c++ code would do; use it for combinational procedures.

Syntax

Non-Blocking

```
variable <= expression;
```

```
variable <= #Δt expression;
grab inputs now, deliver ans.
later, don't delay next statement
```

```
#Δt variable <= expression;
grab inputs later, deliver ans.
later, don't delay next statement.
```

Example 8.3. For simulation, nonblocking may be confusing.

```
initial
begin
#3 b <= a;      /* grab a at t=0 Deliver b at t=3.
#6 x <= b + c; // grab b+c at t=0, wait and assign x at t=6.
                x is unaffected by b's change. */
```

Example 8.4. For synthesis it is best

```
always @(posedge clk)
begin
    Z<=Y; Y<=X; // shift register
    y<=x; z<=y; //also a shift register.
// COMPARE WITH CONFUSING SHIFTS
// USING “=” IN Sect. 8.3.
```

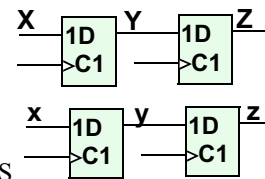

Example 8.3. Use \leq to transform a variable into itself.

```
reg G[7:0];
always @(posedge clk)
    G <= { G[6:0], G[7]}; // End around rotate 8-bit register.
```

The following example shows interactions between blocking and non-blocking for simulation. Do not mix the two types in one procedure for synthesis.

Syntax

Non-Blocking

```
variable <= expression;
variable <= #Δt expression;
#Δt variable <= expression;
```

Blocking

```
variable = expression;
variable = #Δt expression;
#Δt variable = expression;
```

Example 8.4 for simulation only

```
initial begin
    a=1; b=2; c=3; x=4;
#5 a = b + c; // wait for 5 units, then grab b,c and execute a=2+3.
d = a; // Time continues from last line, d=5 = b+c at t=5.
x <= #6 b + c; // grab b+c now at t=5, don't stop, make x=5 at t=11.
b <= #2 a; /* grab a at t=5 (end of last blocking statement).
            Deliver b=5 at t=7. previous x is unaffected by b change. */
y <= #1 b + c; // grab b+c at t=5, don't stop, make x=5 at t=6.
#3 z = b + c; // grab b+c at t=8 (#5+#3), make z=5 at t=8.
w <= x; // make w=4 at t=8. Starting at last blocking assignm.
end
```

8.5. begin ... end

begin ... end block statements are used to group several statements for use where one statement is syntactically allowed. Such places include functions, **always** and **initial** blocks, **if**, **case** and **for** statements.

Blocks can optionally be named. See “disable” on page 15) and can include **reg**, **integer** and **parameter** declarations.

Syntax

```
begin : block_name
  reg [msb:lsb] reg_variable_list;
  integer [msb:lsb] integer_list;
  parameter [msb:lsb] parameter_list;
  ... statements ...
end
```

Example 8.5

```
function trivial_one; // The block name is “trivial_one.”
  input a;
  begin: adder_blk; // block named adder, with
    integer i; // local integer i
    ... statements ...
  end
```

8.6. for Loops

Similar to for loops in C/C++, they are used to repeatedly execute a statement or block of statements. If the loop contains only one statement, the begin ... end statements may be omitted.

Syntax

```
for (count = value1;
     count <=<=>/>= value2;
     count = count +/- step)
  begin
  ... statements ...
  end
```

Example 8.6

```
for (j = 0; j <= 7; j = j + 1)
  begin
    c[j] = a[j] & b[j];
    d[j] = a[j] | b[j];
  end
```

8.7. while Loops

The **while** loop repeatedly executes a statement or block of statements until the expression in the while statement evaluates to false. To avoid combinational feedback during **synthesis**, a while loop must be broken with an **@(posedge/negedge clock)** statement (Section 9.2). For simulation a delay inside the loop will suffice. If the loop contains only one statement, the begin ... end statements may be omitted.

Syntax

```
while (expression)
  begin
  ... statements ...
  end
```

Example 8.7

```
while (!overflow) begin
  @(posedge clk);
  a = a + 1;
end
```

8.8. forever Loops

The forever statement executes an infinite loop of a statement or block of statements. To avoid combinational feedback during **synthesis**, a forever loop must be broken with an **@(posedge/negedge clock)** statement (Section 9.2). For simulation a delay inside the loop will suffice. If the loop contains only one statement, the begin ... end statements may be omitted. It is

Syntax

```
forever
  begin
  ... statements ...
  end
```

Example 8.8

```
forever begin
  @(posedge clk); // or use a = #9 a+1;
  a = a + 1;
end
```

8.9. repeat Not Synthesizable

The repeat statement executes a statement or block of statements a fixed number of times.

Syntax

```
repeat (number_of_times)
  begin
    ... statements ...
  end
```

Example 8.9

```
repeat (2) begin // after 50, a = 00,
  #50 a = 2'b00; // after 100, a = 01,
  #50 a = 2'b01; // after 150, a = 00,
end // after 200, a = 01
```

8.10. disable

Execution of a disable statement terminates a block and passes control to the next statement after the block. It is like the C *break* statement except it can terminate any loop, not just the one in which it appears.

Disable statements can only be used with named blocks.

Syntax

```
disable block_name;
```

Example 8.10

```
begin: accumulate
  forever
    begin
      @(posedge clk);
      a = a + 1;
      if (a == 2'b0111) disable accumulate;
    end
  end
```

8.11. if ... else if ... else

The **if ... else if ... else** statements execute a statement or block of statements depending on the result of the expression following the **if**. If the conditional expressions in all the **if**'s evaluate to false, then the statements in the **else** block, if present, are executed.

There can be as many **else if** statements as required, but only one **if** block and one **else** block. If there is one statement in a block, then the **begin .. end** statements may be omitted.

Both the **else if** and **else** statements are optional. However if all possibilities are not specifically covered, synthesis will generate extra latches.

Syntax

```
if (expression)
  begin
    ... statements ...
  end
else if (expression)
  begin
    ... statements ...
  end
... more else if blocks ...
else
  begin
    ... statements ...
  end
```

Example 8.11

```
if (alu_func == 2'b00)
  aluout = a + b;
else if (alu_func == 2'b01)
  aluout = a - b;
else if (alu_func == 2'b10)
  aluout = a & b;
else // alu_func == 2'b11
  aluout = a | b;

if (a == b) // This if with no else will generate
  begin // a latch for x and ot. This is so they
    x = 1; // will hold there old value if (a != b).
    ot = 4'b1111;
  end
```

8.12. case

The **case** statement allows a multipath branch based on comparing the *expression* with a list of *case choices*.

Statements in the **default** block executes when none of the *case choice* comparisons are true. With no default, if no comparisons are true, synthesizers will generate unwanted latches. Good practice says to make a habit of putting in a default whether you need it or not.

If the defaults are don't cares, define them as 'x' and the logic minimizer will treat them as don't cares and dsave area. Case choices may be a simple constant, expression, or a comma-separated list of same.

Syntax

```

case (expression)
  case_choice1:
    begin
      ... statements ...
    end
  case_choice2:
    begin
      ... statements ...
    end
  ... more case choices blocks ...
  default:
    begin
      ... statements ...
    end
endcase

```

Example 8.12

```

case (alu_ctr)
  2'b00: aluout = a + b;
  2'b01: aluout = a - b;
  2'b10: aluout = a & b;
  default: aluout = 1'bx; // Treated as don't cares for
endcase                // minimum logic generation.

```

Example 8.13

```

case ({w, y})
  2'b00: aluout = a + b; //case if x, y is 2'b00.
  2'b01: aluout = a - b;
  2'b10: aluout = a & b;
  default: $display("Invalid w,y = %b %b ", w, y);
endcase //Display an error if w,y are 11, or contain 'x's.

```

8.13. casex

In **casex(a)** the case choices constant "a" may contain z, x or ? which are used as don't cares for comparison. With **case** the corresponding simulation variable would have to match a tri-state, unknown, or either signal. In short, **case** uses x to compare with an unknown signal. **Casex** uses x as a don't care which can be used to minimize logic.

Syntax

same as for **case** statement
(Section 8.10)

Example 8.12

```

casex (a)
  2'b1x: msb = 1;    // msb = 1 if a = 10 or a = 11
                // If this were case(a) then only a=1x would match.
  default: msb = 0;
endcase

```

8.14. casez

Casez is the same as **casex** except only ? and z (not x) are used in the case choice constants as don't cares. **Casez** is favored over **casex** since in simulation, an inadvertent x signal, will not be matched by a 0 or 1 in the case choice.

Syntax

same as for **case** statement
(Section 8.10)

Example 8.13

```

casez (d)
  3'b1??: b = 2'b11; // b = 11 if d = 100 or greater
  3'b01?: b = 2'b10; // b = 10 if d = 010 or 011
  default: b = 2'b00;
endcase

```

9. Timing Controls

9.1. Delay Control, Not Synthesizable

This specifies the delay time units before a statement is executed during simulation. A delay time of zero can also be specified to force the statement to the end of the list of statements to be evaluated at the current simulation time. See also “Intra-Assignment Delay, Not synthesizable” on p. 17

Syntax

```
#delay statement;
```

Example 9.1

```
#5 a = b + c;    // evaluated and assigned after 5 time units
#0 a = b + c;    // very last statement to be evaluated
```

9.2. Event Control, @

This causes a statement or **begin-end** block to be executed only after specified events occur. An event is a change in a variable, and the change may be: a positive edge, a negative edge, or either (a level change), and is specified by the keyword **posedge**, **negedge**, or no keyword respectively. Several events can be combined with the **or** keyword. Event specification begins with the character **@** and are usually used in **always** statements. See page 18.

For synthesis one cannot combine level and edge changes in the same list.

For flip-flop and register synthesis the standard list contains only a clock and an optional reset.

For synthesis to give combinational logic, the list must specify only level changes and must contain all the variables appearing in the right-hand-side of statements in the block.

Syntax

```
@(posedge variable or
  negedge variable) statement;
```

```
@(variable or variable . . .) statement;
```

Example 9.2

```
always
  @(posedge clk or negedge rst)
    if (rst) Q=0; else Q=D; // Definition for a D flip-flop.
@(a or b or e);           // re-evaluate if a or b or e changes.
sum = a + b + e;          // Will synthesize to a combinational adder.
```

9.3. Wait Statement Not Synthesizable

Delay executing the statement(s) following the wait until the specified condition evaluates to true.

Syntax

```
wait (condition_expression) statement;
```

Example 9.3

```
wait (!c) a = b; // wait until c=0, then assign b to a
```

9.4. Intra-Assignment Delay, Not Synthesizable

This delay $\#\Delta$ is placed after the equal sign. The left-hand assignment is delayed by the specified time units, but the right-hand side of the assignment is evaluated before the delay instead of after the delay. This is important when a variable may be changed in a concurrent procedure. See also “Delay in Assignment (not for synthesis)” on page 12.

Syntax

```
variable = # $\Delta$ t expression;
```

Example 9.4

```
assign a=1; assign b=0;
  always @(posedge clk)
    b = #5 a;           // a = b after 5 time units.
  always @(posedge clk)
    c = #5 b;           /* b was grabbed in this parallel procedure
                        before the first procedure changed it. */
```

10. Procedures: Always and Initial Blocks

10.1. Always Block

The always block is the primary construct in RTL modeling. Like the continuous assignment, it is a concurrent statement that is continuously executed during simulation. This also means that all always blocks in a module execute simultaneously. This is very unlike conventional programming languages, in which all statements execute sequentially. The always block can be used to imply latches, flip-flops or combinational logic. If the statements in the always block are enclosed within **begin ... end**, the statements are executed sequentially. If enclosed within the **fork ... join**, they are executed concurrently (simulation only).

The always block is triggered to execute by the level, positive edge or negative edge of one or more signals (separate signals by the keyword **or**). A double-edge trigger is implied if you include a signal in the event list of the always statement. The single edge-triggers are specified by **posedge** and **negedge** keywords.

Procedures can be named. In simulation one can **disable** named blocks. For synthesis it is mainly used as a comment.

Syntax 1

```
always @(event_1 or event_2 or ...)
  begin
    ... statements ...
  end
```

Syntax 2

```
always @(event_1 or event_2 or ...)
  begin: name_for_block
    ... statements ...
  end
```

Example 10.1

```
always @(a or b) // level-triggered; if a or b changes levels
always @(posedge clk); // edge-triggered: on +ve edge of clk

see previous sections for complete examples
```

10.2. Initial Block

The initial block is like the always block except that it is executed only once at the beginning of the simulation. It is typically used to initialize variables and specify signal waveforms during simulation. Initial blocks are not supported for synthesis.

Syntax

```
initial
  begin
    ... statements ...
  end
```

Example 10.2

```
initial
  begin
    clr = 0; // variables initialized at
    clk = 1; // beginning of the simulation
  end

initial // specify simulation waveforms
  begin
    a = 2'b00; // at time = 0, a = 00
    #50 a = 2'b01; // at time = 50, a = 01
    #50 a = 2'b10; // at time = 100, a = 10
  end
```

11. Functions

Functions are declared within a module, and can be called from continuous assignments, always blocks, or other functions. In a continuous assignment, they are evaluated when any of its declared inputs change. In a procedure, they are evaluated when invoked.

Functions describe combinational logic, and by do not generate latches. Thus an **if** without an **else** will simulate as though it had a latch but synthesize without one. This is a particularly bad case of synthesis not following the simulation. It is a good idea to code functions so they would not generate latches if the code were used in a procedure. Functions are a good way to reuse procedural code, since modules cannot be invoked from within a procedure.

11.1. Function Declaration

A function declaration specifies the name of the function, the width of the function return value, the function input arguments, the variables (reg) used within the function, and the function local parameters and integers.

Syntax, Function Declaration

```
function [msb:lsb] function_name;
  input [msb:lsb] input_arguments;
  reg [msb:lsb] reg_variable_list;
  parameter [msb:lsb] parameter_list;
  integer [msb:lsb] integer_list;
  ... statements ...
endfunction
```

Example 11.1

```
function [7:0] my_func; // function return 8-bit value
  input [7:0] i;
  reg [4:0] temp;
  integer n;
  temp= i[7:4] | ( i[3:0]);
  my_func = {temp, i[[1:0]}};
endfunction
```

11.2. Function Return Value

When you declare a function, a variable is also implicitly declared with the same name as the function name, and with the width specified for the function name (The default width is 1-bit). This variable is “my_func” in Example 11.1 on page 19. At least one statement in the function must assign the function return value to this variable.

11.3. Function Call

As mentioned in Sect. 6.4., a function call is an operand in an expression. A function call must specify in its terminal list all the input parameters.

11.4. Function Rules

The following are some of the general rules for functions:

- Functions must contain at least one input argument.
- Functions cannot contain an inout or output declaration.
- Functions cannot contain time controlled statements (#, @, wait).
- Functions cannot enable tasks.
- Functions must contain a statement that assigns the return value to the implicit function name register.

11.5. Function Example

A Function has only one output. If more than one return value is required, the outputs should be concatenated into one vector before assigning it to the function name. The calling module program can then extract (unbundle) the individual outputs from the concatenated form. Example 11.2 shows how this is done, and also illustrates the general use and syntax of functions in Verilog modeling.

Syntax

function_name = expression

Example 11.2

```

module simple_processor (instruction, outp);
input [31:0] instruction;
output [7:0] outp;
reg [7:0] outp;; // so it can be assigned in always block
reg func;
reg [7:0] opr1, opr2;

function [16:0] decode_add(instr) // returns 1 1-bit plus 2 8-bits
input [31:0] instr;
reg add_func;
reg [7:0] opcode, opr1, opr2;
begin
  opcode = instr[31:24];
  opr1 = instr[7:0];
  case (opcode)
    8'b10001000: begin // add two operands
      add_func = 1;
      opr2 = instr[15:8];
    end
    8'b10001001: begin // subtract two operands
      add_func = 0;
      opr2 = instr[15:8];
    end
    8'b10001010: begin // increment operand
      add_func = 1;
      opr2 = 8'b00000001;
    end
    default: begin; // decrement operand
      add_func = 0;
      opr2 = 8'b00000001;
    end
  endcase
  decode_add = {add_func, opr2, opr1}; // concatenated into 17-bits
end
endfunction
// -----
always @(instruction) begin
  {func, op2, op1} = decode_add(instruction); // outputs unbundled
  if (func == 1)
    outp = op1 + op2;
  else
    outp = op1 - op2;
  end
endmodule

```

Diagram annotations in the code block:

- A bracket labeled "bundle" spans the concatenation of `add_func`, `opr2`, and `opr1` in the `decode_add` function definition.
- A bracket labeled "unbundle" spans the assignment of `{func, op2, op1}` in the `always` block.
- A red vertical bar is located to the left of the `always` block.

12. Tasks, Not Synthesizable

A task is similar to a function, but unlike a function it has both input and output ports. Therefore tasks do not return values. Tasks are similar to procedures in most programming languages. The syntax and statements allowed in tasks are those specified for functions (Sections 11).

Syntax

```

task task_name;
  input [msb:lsb] input_port_list;
  output [msb:lsb] output_port_list;
  reg [msb:lsb] reg_variable_list;
  parameter [msb:lsb] parameter_list;
  integer [msb:lsb] integer_list;
  ... statements ...
endtask

```

Example 12.1

```

module alu (func, a, b, c);
  input [1:0] func;
  input [3:0] a, b;
  output [3:0] c;
  reg [3:0] c;    // so it can be assigned in always block

  task my_and;
    input[3:0] a, b;
    output [3:0] andout;
    integer i;
    begin
      for (i = 3; i >= 0; i = i - 1)
        andout[i] = a[i] & b[i];
    end
  endtask

  always @(func or a or b) begin
    case (func)
      2'b00: my_and (a, b, c);
      2'b01: c = a | b;
      2'b10: c = a - b;
      default: c = a + b;
    endcase
  end
endmodule

```

13. Component Inference

13.1. Latches

A latch is inferred (put into the synthesized circuit) if a variable, or one of its bits, is not assigned in all branch of an if statement. A latch is also inferred in a case statement if a variable is assigned to in only some of the branches.

To improve code readability, use the if statement to synthesize a latch because it is difficult to explicitly specify the latch enable signal using a case statement.

While in theory, a proper reset should be inferred from the Verilog code shown, Synopsys will not do a proper job without adding the //Synopsys comments shown.

Syntax

See Sect. 8.11. and Sect. 8.12. for
if ... else if ... else and case statements

//Synopsys statement

These are treated as comments by all simulators. For synthesis using Synopsys, they direct the synthesizer as to what particular inference is wanted.

Example 13.1

```
always @(clk,d); begin
  if (clk)
    q <= d;
end
```

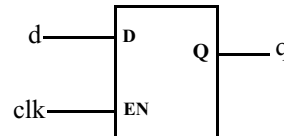

Example 13.2

```
//Synopsys async_set_reset "rst"
always @(clk or rst or d); begin
  if (rst) q <= 0;
  else if (clk) q <= d;
end
```

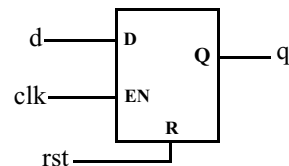

13.2. Edge-Triggered Registers, Flip-flops, Counters

A register (flip-flop) is inferred by using posedge or negedge clause for the clock in the event list of an always block. To add an asynchronous reset, include a second posedge/negedge for the reset and use the if (reset) ... else statement. Note that when you use the negedge for the reset (active low reset), the if condition is (!reset).

Syntax

```
always @(posedge clk or
        posedge reset_1 or
        negedge reset_2)
begin
  if (reset_1) begin
    ... reset assignments
  end
  else if (!reset_2) begin
    ... reset assignments
  end
  else begin
    ... register assignments
  end
end
```

Example 13.3

```
always @(posedge clk);
begin;
  a <= b & c;
end

always @(posedge clk or
        negedge rst);
begin;
  if (!rst) a <= 0;
  else a <= b;
end
```

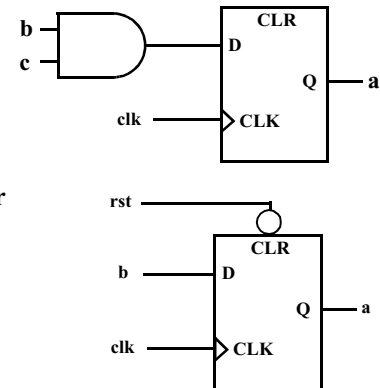

Example 13.4 An Enabled Counter

```
reg [7:0] count;
wire enable;
always @(posedge clk or posedge rst) // Do not include enable.
begin;
  if (rst) count <= 0;
  else if (enable) count <= count+1;
end; // 8 flip-flops will be generated.
```

13.3. Multiplexers

A multiplexer is inferred by assigning a variable to different variables/values in each branch of an if or case statement. You can avoid specifying each and every possible branch by using the else and default branches. Note that a latch will be inferred if a variable is not assigned to for all the possible branch conditions.

To improve readability of your code, use the case statement to model large multiplexers.

Syntax

See Sections 8.9 and 8.10 for
if ... else if ... else and **case** statements

Example 13.5

```

if (sel == 1)
  y = a;
else
  y = b;

case (sel)
  2'b00: y = a;
  2'b01: y = b;
  2'b10: y = c;
  default: y = d;
endcase

```

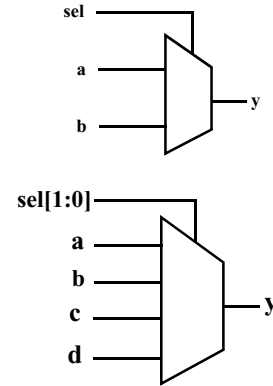

13.4. Adders/Subtractors

The +/- operators infer an adder/subtractor whose width depend on the width of the larger operand.

Syntax

See Section 7 for operators

Example 13.6

```

if (sel == 1)
  y = a + b;
else
  y = c + d;

```

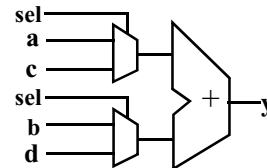

13.5. Tri-State Buffers

A tristate buffer is inferred if a variable is conditionally assigned a value of z using an if, case or conditional operator.

Syntax

See Sections 8.9 and 8.10 for
if ... else if ... else and **case** statements

Example 13.7

```

if (en == 1)
  y = a;
else
  y = 1'bz;

```

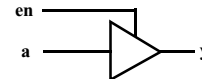

13.6. Other Component Inferences

Most logic gates are inferred by the use of their corresponding operators. Alternatively a gate or component may be explicitly instantiated by using the primitive gates (**and**, **or**, **nor**, **inv** ...) provided in the Verilog language.

14. Finite State Machines. For synthesis

When modeling finite state machines, it is recommended to separate the sequential current-state logic from the combinational next-state and output logic.

State Diagram

for lack of space the outputs are not shown on the state diagram, but are:

in state0: Zot = 000,
in state1: Zot = 101,
in state2: Zot = 111,
in state3: Zot = 001.

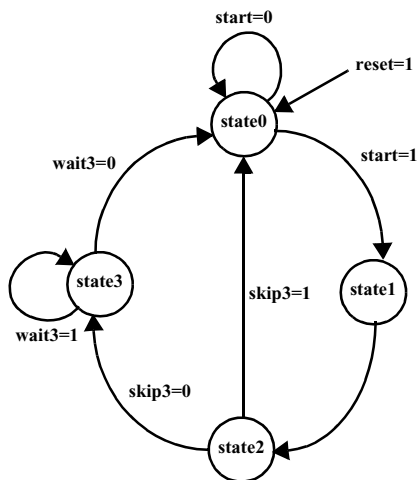

Using Macros for state definition

As an alternative for-

```
parameter state0=0, state1=1,
             state2=2, state3=3;
```

one can use macros. For example after the definition below 2'd0 will be textually substituted whenever `state0 is used.

```
define state0 2'd0
`define state1 2'd1
`define state2 2'd
`define state3 2'd3;
```

When using macro definitions one must put a back quote in front. For example:

```
case (state)
  `state0: Zot = 3'b000;
  `state1: Zot = 3'b101;
  `state2: Zot = 3'b111;
  `state3: Zot = 3'b001;
```

Example 14.1

```
module my_fsm (clk, rst, start, skip3, wait3, Zot);
input clk, rst, start, skip3, wait3;
output [2:0] Zot; // Zot is declared reg so that it can
reg [2:0] Zot; // be assigned in an always block.
parameter state0=0, state1=1, state2=2, state3=3;
reg [1:0] state, nxt_st;

always @ (state or start or skip3 or wait3)
begin : next_state_logic //Name of always procedure.
  case (state)
    state0: begin
      if (start) nxt_st = state1;
      else nxt_st = state0;
      end

    state1: begin
      nxt_st = state2;
      end

    state2: begin
      if (skip3) nxt_st = state0;
      else nxt_st = state3;
      end

    state3: begin
      if (wait3) nxt_st = state3;
      else nxt_st = state0;
      end

    default: nxt_st = state0;
  endcase // default is optional since all 4 cases are
end // covered specifically. Good practice says uses it.

always @(posedge clk or posedge rst)
begin : register_generation
  if (rst) state = state0;
  else state = nxt_st;
end

always @(state) begin : output_logic
  case (state)
    state0: Zot = 3'b000;
    state1: Zot = 3'b101;
    state2: Zot = 3'b111;
    state3: Zot = 3'b001;
    default: Zot = 3'b000; // default avoids latches
  endcase
end
endmodule
```

14.1.

14.2. Counters

Counters are a simple type of finite-state machine where separation of the flip-flop generation code and the next-state generation code is not worth the effort. In such code, use the nonblocking “<=” assignment operator.

Binary Counter

Using toggle flip-flops

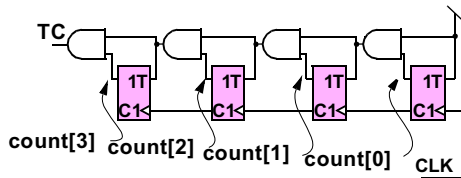

Example 14.2

```
reg [3:0] count; wire TC; // Terminal count (Carry out)
always @(posedge clk or posedge rset)
begin
  if (rset) count <= 0;
  else count <= count+1;
end
assign TC = & count; // See "Reduction Operators" on page 7
```

14.3. Shift Registers

Shift registers are also best done completely in the flip-flop generation code. Use the nonblocking “<=” assignment operator so the operators “<< N” shifts left N bits. The operator “>>N” shifts right N bits. See also Example 8.3. on page 12.

Shift Register

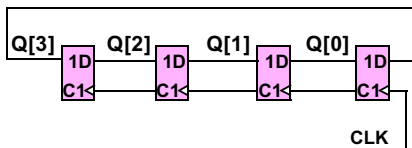

Example 14.3

```
reg [3:0] Q;
always @(posedge clk or posedge rset)
begin
  if (rset) Q <= 0;
  else begin
    Q <= Q << 1; // Left shift 1 position
    Q[0] <= Q[3]; /* Nonblocking means the old Q[3] is sent
to Q[0]. Not the revised Q[3] from the previous line.
  end
```

Linear-Feedback Shift Register

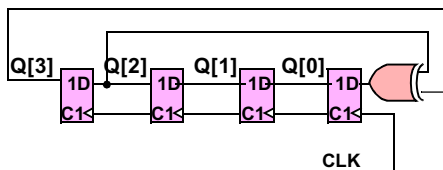

Example 14.4

```
reg [3:0] Q;
always @(posedge clk or posedge rset)
begin
  if (rset) Q <= 0;
  else begin
    Q <= {Q[2:1]: Q[3]^Q[2]; /* The concatenation operators
"...}" form the new Q from elements of the old Q. */
  end
end
```

15. Compiler Directives

Compiler directives are special commands, beginning with ```, that affect the operation of the Verilog simulator. The Synopsys Verilog HDL Compiler/Design Compiler and many other synthesis tools parse and ignore compiler directives, and hence can be included even in synthesizable models. Refer to *Cadence Verilog-XL Reference Manual* for a complete listing of these directives. A few are briefly described here.

15.1. Time Scale

``timescale` specifies the time unit and time precision. A time unit of 10 ns means a time expressed as say #2.3 will have a delay of 23.0 ns. Time precision specifies how delay values are to be rounded off during simulation. Valid time units include s, ms, us (μ s), ns, ps, fs.

Only 1, 10 or 100 are valid integers for specifying time units or precision. It also determines the displayed time units in display commands like `$display`

Syntax

```
`timescale time_unit / time_precision;
```

Example 15.1

```
`timescale 1 ns/1 ps // unit =1ns, precision=1/1000ns
`timescale 1 ns/100 ps // time unit = 1ns; precision = 1/
10ns;
```

15.2. Macro Definitions

A macro is an identifier that represents a string of text. Macros are defined with the directive ``define`, and are invoked with the quoted macro name as shown in the example. Verilog compilers will substitute the string for the macro name before starting compilation. Many people prefer to use macros instead of parameters. See Sect. 4.8.

Syntax

```
`define macro_name text_string;
... `macro_name ...
```

Example 15.2

```
`define add_lsb a[7:0] + b[7:0]
`define N 8 // Word length
wire [N-1:0] S;
assign S = 'add_lsb; // assign S = a[7:0] + b[7:0];
```

15.3. Include Directive

`include` is used to include the contents of a text file at the point in the current file where the include directive is. The include directive is similar to the C/C++ include directive.

Syntax

```
`include file_name;
```

Example 15.3

```
module x;
  `include "dclr.v"; // contents of file "dclr.v" are put here
```

16. System Tasks and Functions

These are tasks and functions that are used to generate input and output during simulation. Their names begin with a dollar sign (\$). The Synopsys Verilog HDL Compiler/Design Compiler and many other synthesis tools parse and ignore system functions, and hence can be included even in synthesizable models. Refer to *Cadence Verilog-XL Reference Manual* for a complete listing of system functions. A few are briefly described here.

System tasks that extract data, like **\$monitor** need to be in an **initial** or **always** block.

16.1. Display Selected Variables; \$display, \$strobe, \$monitor

These commands have the same syntax, and display text on the screen during simulation. They are much less convenient than waveform display tools like *cwaves*[®] or *Signalscan*[®]. **\$display** and **\$strobe** display once every time they are executed, whereas **\$monitor** displays every time one of its parameters changes. The difference between **\$display** and **\$strobe** is that **\$strobe** displays the parameters at the very end of the current simulation time unit rather than exactly where it is executed. The format string is like that in C/C++, and may contain format characters. Format characters include %d (decimal), %h (hexadecimal), %b (binary), %c (character), %s (string) and %t (time), %m (hierarchy level). %5d, %5b etc. would give exactly 5 spaces for the number instead of the space needed. Append **b**, **h**, **o** to the task name to change default format to binary, octal or hexadecimal.

Syntax

\$display (“format_string”, par_1, par_2, ...);
\$strobe (“format_string”, par_1, par_2, ...);
\$monitor (“format_string”, par_1, par_2, ...);
\$displayb (as above but defaults to binary..
\$strobeh (as above but defaults to hex..
\$monitoro (as above but defaults to octal..

Example 16.1

```
initial begin // c below is in submodule submod1.
  $displayh (b, d, submod1.c); //No format, display in hex.
  $monitor (“time=%t, d=%h, c=%b”,
           $time, a, submod1.c);
end
```

16.2. \$time, \$stime, \$realttime

These return the current simulation time as a 64-bit integer, a 32-bit integer, and a real number, respectively. Their use is illustrated in Examples 4.7. and 15 .1.

16.3. \$reset, \$stop, \$finish

\$reset resets the simulation back to time 0; **\$stop** halts the simulator and puts it in the interactive mode where the user can enter commands; **\$finish** exits the simulator back to the operating system.

16.4. \$deposit

\$deposit sets a net to a particular value, overwriting what was put there by the “circuit”. Good for test benches.

Syntax

\$deposit (net_name, value);

Example 16.2

```
$deposit (b, 1'b0);
$deposit (outp, 4'b001x); // outp is a 4-bit bus
```

16.5. \$scope, \$showscope

\$scope(hierarchy_name) sets the current hierarchical scope to hierarchy_name. **\$showscopes**(n) lists all modules, tasks and block names in (and below, if n is set to 1) the current scope.

16.6. \$list

\$list (hierarchical_name) lists line-numbered source code of the named module, task, function or named-block.

16.7. \$rrandom

\$rrandom generates a random integer every time it is called. If the sequence is to be repeatable, the first time one invokes random give it a numerical argument (a seed). Otherwise the seed is derived from the computer clock.

Syntax

```
xzz = $rrandom[(integer)];
```

Example 16.3

```
reg [3:0] xyz;
initial begin
    xyz= $rrandom (7); // Seed the generator so number
    // sequence will repeat if simulation is restarted.
    forever xyz = #20 $rrandom;
    // The 4 lsb bits of the random integers will transfer into the
    // xyz. Thus xyz will be a random integer  $0 \leq xyz \leq 15$ .
```

16.8. \$dumpfile, \$dumpvar, \$dumpon, \$dumpoff, \$dumpall

These can dump variable changes to a simulation viewer like *cwaves*[®]. The dump files are capable of dumping all the variables in a simulation. This is convenient for debugging, but can be very slow.

Syntax

\$dumpfile("filename.dmp")

\$dumpvar dumps all variables in the design.

\$dumpvar(1, top) dumps all the variables in module top and below, but not modules instantiated in top.

\$dumpvar(2, top) dumps all the variables in module top and 1 level below.

\$dumpvar(n, top) dumps all the variables in module top and n-1 levels below.

\$dumpvar(0, top) dumps all the variables in module top and all level below.

\$dumpon initiates the dump.

\$dumpoff stop dumping.

Example 16.4

```
// Test Bench
module testbench:
    reg a, b; wire c;
    initial begin;
        $dumpfile("cwave_data.dmp");
        $dumpvar //Dump all the variables
    // Alternately instead of $dumpvar, one could use
        $dumpvar(1, top) //Dump variables in the top module.
    // Ready to turn on the dump.
        $dumpon
            a=1; b=0;
            topmodule top(a, b, c);
    end
```

16.9. \$shm_probe, \$shm_open

These are special commands for the *Simulation History Manager* for Cadence *cwaves*[®] only. They will save variable changes for later display.

Syntax

\$shm_open ("cwave_dump.dm")

\$shm_probe (var1,var2, var3);

/ Dump all changes in the above 3 variables. */*

\$shm_probe(a, b, inst1.var1, inst1.var2);

/ Use the qualifier inst1. to look inside the hierarchy. Here inside module instance "inst1" the variables var1 and var2 will be dumped.*/*

Example 16.5

```
// Test Bench
module testbench:
    reg a, b; wire c;
    initial begin;
        $shm_open("cwave_data.dmp");
        $shm_probe(a, b, c)
    // See also the testbench example in "Test Benches" on p. 30
```

16.10. Writing to a File; \$fopen, \$fdisplay, \$fstrobe \$fmonitor and \$fwrite

These commands write more selectively to files.

\$fopen opens an output file and gives the open file a handle for use by the other commands.

\$fclose closes the file and lets other programs access it.

\$fdisplay and **\$fwrite** write formatted data to a file whenever they are executed. They are the same except **\$fdisplay** inserts a new line after every execution and **\$fwrite** does not.

\$fstrobe also writes to a file when executed, but it waits until all other operations in the timestep are complete before writing. Thus initial #1 a=1; b=0; \$fstrobe(hand1, a,b); b=1; will write write 1 1 for a and b.

\$fmonitor writes to a file whenever any one of its arguments changes.

See “Display Selected Variables; \$display, \$strobe, \$fmonitor” on page 27 for the meaning of %h, %b etc in the example.

Syntax

```
handle1=$fopen("filenam1.suffix")
```

```
handle2=$fopen("filenam2.suffix")
```

```
$fstrobe(handle1, format, variable list)
```

```
//strobe data into filenam1.suffix
```

```
$fdisplay((handle2, format, variable list)
```

```
//write data into filenam2.suffix
```

```
$fwrite((handle2, format, variable list)
```

```
//write data into filenam2.suffix all on
```

```
// one line. Put \n in the format string
```

```
// where a new line is desired.
```

See Sect 16.1.for examples of format.

Example 16.6 Output values every clock cycle

```
// Test Bench
```

```
module testbench:
```

```
reg [15:0]a; reg clk; integer hand1;
```

```
initial begin;
```

```
hand1=$fopen("datastuff.txt");
```

```
forever @(posedge clk) begin
```

```
    $fstrobe (hand1, "time=%5t, a=%h, c=%b",
```

```
                $time, a, submod1.c);
```

```
end // Never put statements after a forever block.
```

```
end
```

```
initial begin
```

```
clk=0; a=8'h2b;
```

```
forever #5 clk=~clk;
```

```
end // Never put statements after a forever block
```

```
initial begin
```

```
a=a+8;
```

```
#3000 $fclose (hand1); // Close the file
```

```
$finish;
```

```
end
```

```
submod submod1(a, clk); // with internal variable c.
```

```
endmodule
```

```
----- Output -----
```

```
time= 5, a=2b, c=0
```

```
time= 10, a=2c, c=1
```

17. Test Benches

A test bench supplies the signals and dumps the outputs to simulate a Verilog design (module(s)). It invokes the design under test, generates the simulation input vectors, and implements the system tasks to view/format the results of the simulation. It is never synthesized so it can use all Verilog commands.

To view the waveforms when using Cadence Verilog XL Simulator, use the Cadence-specific Simulation History Manager (SHM) tasks of `$shm_open` to open the file to store the waveforms, and `$shm_probe` to specify the variables to be included in the waveforms list. You can then use the Cadence `cwaves` waveform viewer by typing `cwaves &` at the UNIX prompt.

Syntax

```
$shm_open(filename);
$shm_probe(var1, var2, ...)
```

Note also

```
var=$random
wait(condition) statement
```

Example 17.1

```
'timescale 1 ns /100 ps // time unit = 1ns; precision = 1/10 ns;
module my_fsm_tb; // Test Bench of FSM Design of Example 14.1
/* ports of the design under test are variables in the test bench */
reg clk, rst, start, skip3, wait3;
wire Button;

    /**** DESIGN TO SIMULATE (my_fsm) INSTANTIATION *****/
my_fsm dut1 (clk, rst, start, skip3, wait3, Button);

    /**** SECTION TO DISPLAY VARIABLES *****/
initial begin
    $shm_open("sim.db"); //Open the SHM database file
    /* Specify the variables to be included in the waveforms to be
       viewed by Cadence cwaves */
    $shm_probe(clk, reset, start);
    // Use the qualifier dut1. to look at variables inside the instance dut1.
    $shm_probe(skip3, wait3, Button, dut1.state, dut1.next_st);
end

    /**** RESET AND CLOCK SECTION *****/
initial begin
    clk = 0; rst=0;
    #1 rst = 1; // The delay gives rst a posedge for sure.
    #200 rst = 0; // Deactivate reset after two clock cycles +1 ns*/
end
always #50 clk = ~clk; // 10 MHz clock (50*1 ns*2) with 50% duty-cycle

    /**** SPECIFY THE INPUT WAVEFORMS skip3 & wait3 *****/
initial begin
    skip3 = 0; wait3 = 0; // at time 0, wait3=0, skip3=0
    #1; // Delay to keep inputs from changing on clock edge.
    #600 skip3 = 1; // at time 601, wait3=0, skip3=1
    #400 wait3 = 1; // at time 1001, wait3=1, skip3=0
        skip3 = 0;
    #400 skip3 = 1; // at time 1401, wait3=1, skip3=1
    wait(Button) skip3 = 0; // Wait until Button=1, then make skip3 zero.
        wait3 = $random; //Generate a random number, transfer lsb into wait3
    $finish; // stop simulation. Without this it will not stop.
end
endmodule
```

17.1. Synchronous Test Bench

In synchronous designs, one changes the data during certain clock cycles. In the previous test bench one had to keep counting delays to be sure the data came in the right cycle. With a synchronous test bench the input data is stored in a vector or array and one part injected in each clock cycle. The Verilog array is defined in Section 18.

This test bench also waits for the result from the input and prints out a message using `$display` if the result is not as expected.

The **disable** statement, Sect. 16.10. and **\$deposit** Sect. 16.4. , may also be useful in synchronous test benches. Synchronous test benches are essential for cycle based simulators, which do not use any delays smaller than a clock cycle.

Things to note:

```
data[8:1]=8'b1010_1101;
```

The underscore visually separates the bits. It is ignored by the simulator.

```
if (I==9) $finish;
```

When the data is used up, finish

```
x<=data[I]; I<=I+1;
```

When synthesizing to flip-flops as in an @posedge... procedure, always use nonblocking. Without that you will be racing with the flip-flops in the other modules.

Example 17.2

```
// Synchronous test bench
module SynchTstBch:
  reg [8:1] data;
  reg x,clk;
  wir y;
  integer I;

  initial begin
    data[8:1]=8'b1010_1101; // Underscore spaces bits.
    I=1;
    x=0;
    clk=0;
    forever #5 clk= ~clk;
    // Any statements placed after forever will never be reached!
  end

  /** Send in a new value of x every 3rd clock cycle***/
  always
  begin: data_in_proc
    @(posedge clk)
      if (I=9) $finish; // End of simulation
      @(posedge clk) // Wait here for the 2nd clock edge.
      @(posedge clk) // After the 3rd edge, execute begin ...
      begin
        #1; // Keeps data from changing on clock edge.
        x<=data[I];
        // Wait for y to responded (change);
        @(negedge clk)
      // Check the result; print a warning if it is not as expected.
        if (x != y) $display ("x != y, x=%b, y=%b," x , y);
        I<=I+1;
      end
    end // data_in_proc
  topmod top1(clk, x);
endmodule
```

18. Memorys

18.1. Two-Dimensional Arrays

Two dimensional arrays can be declared and accessed by word. To get at a bit(s) one must equate the output to a register or wire and select the bits from this new variable. See Example 18 .1

18.1.1 Initializing Memory From a File

The command **\$readmemb** will read a file of binary numbers into the array. The data file consists of addresses and data. An address written in hex as *@hhh...* and indicates the address of the first word in a block of data. It is followed by binary data words separated by blanks. Legal binary bits are “0 1 x X z Z _”. Data not included in the file will be given xxx... values. The data may be given in noncontiguous blocks if an address precedes each block. If no initial address is given, @000 is assumed for the first data word. Comments are allowed in data files.

If *start_addr* is given the memory array will be filled starting at that address and continue until *finish_addr* (or the end of the array) is reached. One must have *start address* ≤ *@hhh...*, the initial address in the file.

The command **\$readmemh** is similar except the data must contain hexadecimal numbers.

Syntax

```
reg [wordsize:0] array [0:arraysize]
```

```
readmemb("file_name", array_name);
```

```
readmemb("file_name", array_name,
start_addr);
```

```
readmemb("file_name", array_name,
start_addr, finish_addr);
```

```
readmemh("file_name", array_name);
```

// start_addr and finish_addr are optional

Example 18 .1

```
reg [7:0] memry [0:31]; // 32 byte memory.
```

```
wire [7:0] memwrdr;
```

```
wire x;
```

```
initial begin
```

```
    // Initialize memory contents from file.
```

```
    $readmemb("init.dat", memry, 8);
```

```
    // words 8 and 9 are not in the file and will default to x.
```

```
end
```

```
---
```

```
// Extract last word in memory.
```

```
assign memwrdr= memry[31];
```

```
// Extract most sig bit in word 31
```

```
assign x= memwrdr[7];
```

```
----- file init.dat-----
// Since start_addr =8 memry[0:9] will all be stored as xxxxxxxx.
@00A //
10101100 11110000 1x000x11 11110101 01011010 01001100
XxxxZzzz 00000000
@01E // 5'h1E = 5'd30. Underscore gives readability.
1100_1010 00011_0001
```