

What's inside

- 2 New time-domain technique for measuring mixer group delay
- 3 Uncertainty in mixer group-delay measurements
- 5 Isolation a problem? Here's how to measure mixer group delay
- 6 Low-power mixer design using the Advanced Design System
- 7 Let RF experts train your team
- 8 What's new from Agilent Technologies



Visit our new
Component Test Industry
website at

www.agilent.com/find/component_test

Welcome to the first *Device Test Forum* from Agilent Technologies, a new company with the Hewlett-Packard tradition of technical innovation and business expertise. The *Device Test Forum* continues to bring you the latest tips and techniques for improving the measurement speed, accuracy, and production throughput of RF and microwave devices, helping you reduce your cost of test.



Steve Scalmanini
Editor, *Device Test Forum*

device TEST FORUM

Highlights

Improving group delay measurements

The following articles introduce a new, more accurate technique for measuring mixer group delay, and compare the uncertainties inherent in other common techniques. We describe a group-delay measurement technique to use when a device contains isolation and provide some tips on designing low-power mixers using the Agilent EEsof EDA Advanced Design System.

Mixer test — third in a series

In this issue of *Device Test Forum* we focus on mixer test, continuing our series on testing basic RF devices.

You can download this and past issues of *Device Test Forum* devoted to topics such as amplifier and filter test from the Web:

www.agilent.com/find/DeviceTestForum

To locate Agilent's application literature and sign up to receive future RF and microwave news on-line, visit our home page at

www.agilent.com



Agilent Technologies
Innovating the HP Way

New time-domain technique for measuring mixer group delay

Conventional techniques for measuring mixer group delay contain multiple uncertainties. Here is a new technique we've developed that contains less uncertainty when measuring both absolute delay and delay linearity. It uses only a single broadband mixer and a vector network analyzer (VNA) with a time domain option. The technique requires that you terminate the mixer's IF port with a 50-ohm airline and a short (see Figure 1).

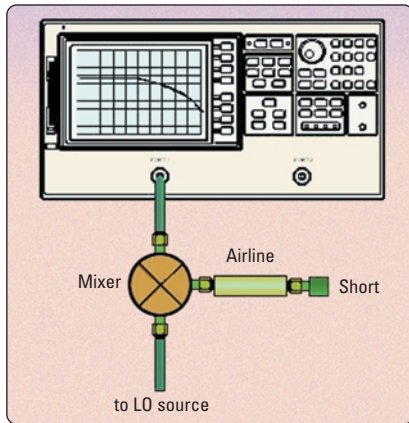

Figure 1. Configuration for measuring group delay

Measurement process

This new technique measures the frequency response of the mixer's reflection coefficient. This frequency response is transformed into an impulse response using the VNA's time-domain option. Knowing the absolute delay of the airline, which must have been previously measured using a conventional technique for a linear device, you can examine the two-way reflection from the short in the time domain and then calculate the absolute delay through the mixer.

A typical example is shown in Figure 2. The mixer's frequency response has been transformed to the time domain, and the equivalent time domain reflectometry (TDR) measurement is shown directly on the VNA's display.

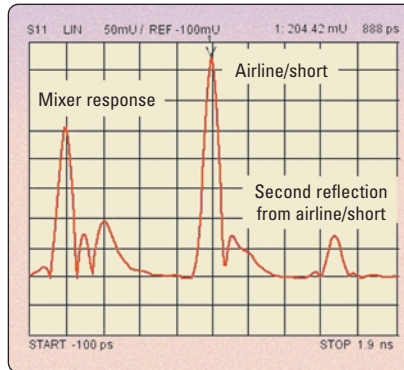

Figure 2. Absolute delay measurements

Place a marker on the reflection peak from the short and measure the two-way delay through the mixer and airline. Divide this delay value in half and subtract the transmission delay through the airline. This is the absolute delay through the mixer.

Measure the delay linearity of the mixer using a time filter, or gating function, on the VNA. Set the gating function so that only the reflection from the short is transformed back to the frequency domain. Figure 3 shows the gated response of the reflection from the short. The gate removes the effects of the mixer's internal reflections and isolates only the transmitted signal, which contains the delay distortion introduced by the frequency translation process. Next, turn off the time-domain transformation, which displays the gated signal's frequency response. Select delay on the analyzer to display the group delay of the mixer, as shown in Figure 4.

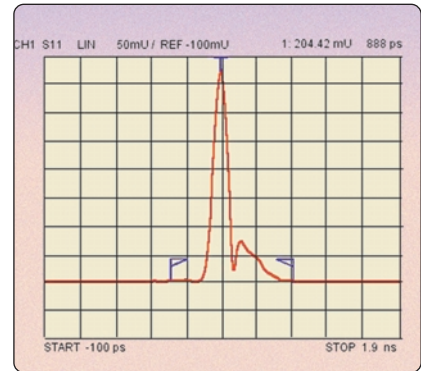

Figure 3. Gated time domain response of the mixer

Measurement considerations

If the mixer contains any components with isolation, such as isolators or amplifiers, then the reflected signal from the short might be too low for accurate measurement by the VNA.

The mixer must also have very broadband characteristics. It is essential to measure a large frequency range in order to adequately resolve the signals reflected from the short, relative to the other reflections in the measurement.

Today's mixer-test challenges

Mixers are frequency-translation devices that present unique measurement challenges because they have more than two ports, and stimulus and response occur at different frequencies.

Classic mixer measurements are conversion loss, reflection coefficient, and isolation. As bandwidths become wider and modulation more complex, system designers are specifying tighter device tolerances, particularly for phase distortion and group delay.

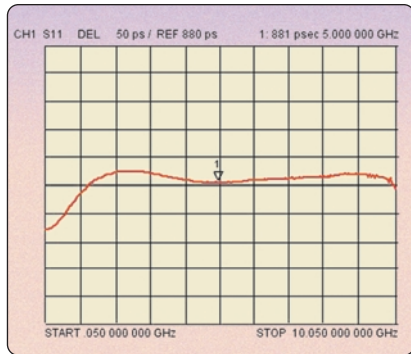



Figure 4. Gated frequency response of the mixer's delay

Finally, this new measurement technique assumes that the device under test is reciprocal—that one-way transmission through the mixer is identical when measured from the RF to IF ports and from the IF to RF ports. Any difference in these transmitted responses will introduce uncertainty into the calculations.

This new technique, however, avoids the additional uncertainties of other techniques such as two mixer up/down conversion and modulation delay, as explained in the next article.

 Check item 1 on the business reply card to receive Agilent's newest application note on measuring mixers, or download it from our website:

www.tm.agilent.com/tmo/Notes/English/5966-3318E.html

What is group delay?

Group delay is a measure of the transit time of a signal through a device versus the signal frequency. The term is defined classically as the negative derivative of transmission phase versus frequency, as illustrated in Figure A.

Often group delay is a more accurate measure of phase distortion than is the peak-to-peak value of phase ripple. Two devices with the same peak-to-peak phase ripple may have very different group delay and, therefore, very different phase distortion, as shown in Figure B. The less variance in a device's group delay, the closer its output signal matches its input signal.

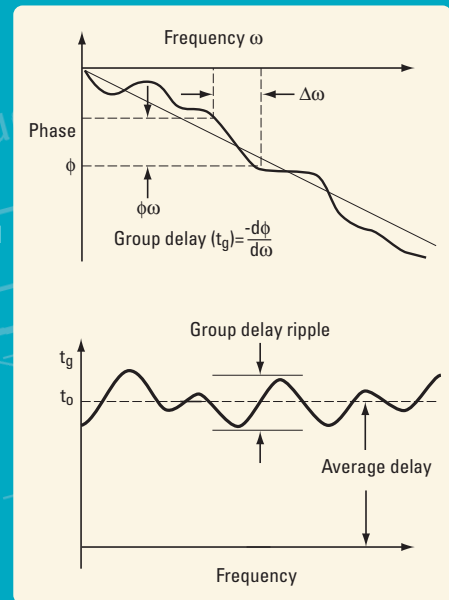

Figure A.

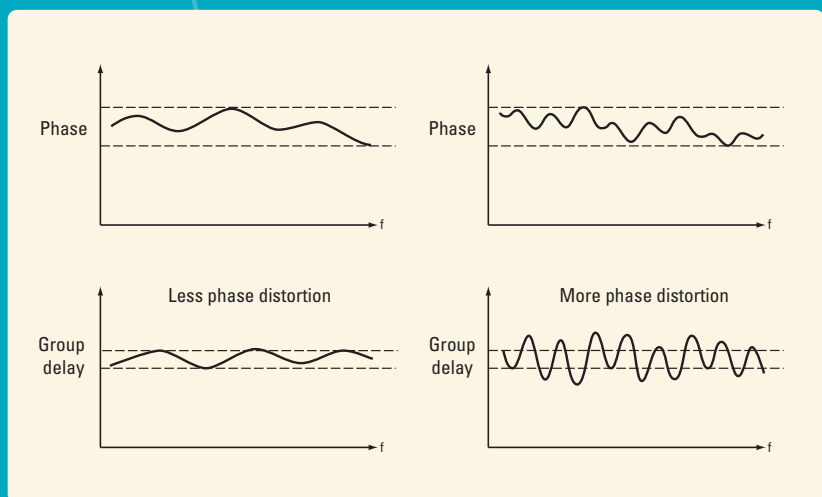

Figure B.

Uncertainty in mixer group-delay measurements

Now let's consider the uncertainties inherent in two commonly used techniques for measuring mixer group delay: two-mixer up/down conversion, and modulation delay.

Measurement techniques

Up/down conversion

This method uses a second mixer to convert the output frequency of the mixer under test (MUT) back to the input frequency. This technique lets you use a vector network analyzer (VNA) in its normal mode, with the source and receiver ports at the same frequency. The VNA's receiver measures the combination of conversions of the up-converter and the down-converter. Typically a filter is placed between these devices to keep the unwanted conversion sideband of the first mixer from entering the second mixer and converting back to the input frequency.

Modulation delay

A second technique is based on the definition of group delay as the time delay of a modulated signal through the MUT. A signal with amplitude, frequency, or phase modulation is applied to the mixer. The modulation is detected at the output, the modulation waveforms are compared, and the delay of the signal is calculated.

Measurement uncertainties

Up/down conversion

The major uncertainty in the up/down conversion method is in determining the delay and the amplitude response of the second mixer. One traditional technique for removing the effects of the second mixer uses two small calibration mixers back-to-back in an up/down conversion configuration, with the requisite filter between them. The measured delay is the sum of the delay of the first mixer, the delay of the second mixer, and the delay of the filter. The delay of the filter, measured previously, is subtracted, and the remaining delay is divided in two and assigned to each mixer. The uncertainty is the delay measured. By using physically small calibration mixers, which have the smallest group delay (less than 500 ps), you can measure devices with greater delays. This technique assumes that the mixers do not have negative delay and are reciprocal.

If the mixers are of the same type, the delay in each should be approximately the same and, thus, the error much less than assumed above. However, even if the pair of mixers has the same delay measured as up/down and down/up, the mixers are not necessarily reciprocal. A single mixer may behave entirely differently as an up-converter than as a down-converter, but the up/down combination can still measure the same. The difference between the amplitude conversions

of a single mixer used as an up-converter and a down-converter can be substantial, so a difference in the phase or delay response is likely. The difference in amplitude and phase performance between two unlike mixers, both used as down-converters, may be much less.

Finally, the connections between the mixers and the intermediate filter create uncorrected mismatch. These uncertainties must be summed in order to determine the overall uncertainty, as they are not random but systematic errors. Summed together, the uncertainties due to mismatch, delay aperture, and delay in the second mixer can easily swamp the error in the assumption that the mixer has similar up- and down-conversion characteristics.

Modulation delay

If the device you are measuring with the modulation delay technique does not have flat delay, the higher frequencies will be delayed differently than the lower frequencies. Secondly, if you are using a broadband detector, both sidebands of the mixer will show up in the detector. If the measurement includes a filter, you must account for the filter response and mismatch. In most detectors, noise in the detection system limits the lowest frequency to the kilohertz to megahertz range, thus setting the minimum aperture.



Check item 1 on the business reply card to receive Agilent's newest application note on measuring mixers, or download it from our website:

www.tm.agilent.com/tmo/Notes/English/5966-3318E.html

Isolation a problem? Here's how to measure mixer group delay

Measuring group delay of frequency translating devices with a vector network analyzer poses problems if the device contains internal isolation such as isolators or an amplifier, or if the local oscillator (LO) is not accessible. It is not possible at all if the system's input and output are in separate geographic locations. In these cases, you'll need a flexible tool to make the group-delay measurement over a wide frequency range without requiring that input and output frequencies match.

One solution uses four key components:

- * The Agilent 71500 microwave transition analyzer (MTA)
- * A signal source with AM, FM or pulse modulation capability
- * A computer to process the data
- * A modulation source (either from a signal generator internal to the signal source, or a precise timing system if the input and output locations are separated).

The 71500 MTA uses modulation delay to measure group delay with accuracy of less than 1 nsec at frequencies up to 40 GHz. No additional upconverters or down-converters are necessary. A modulated carrier is passed through the DUT, and then demodulated. The phase of the demodulated signal is compared to the original modulating signal to

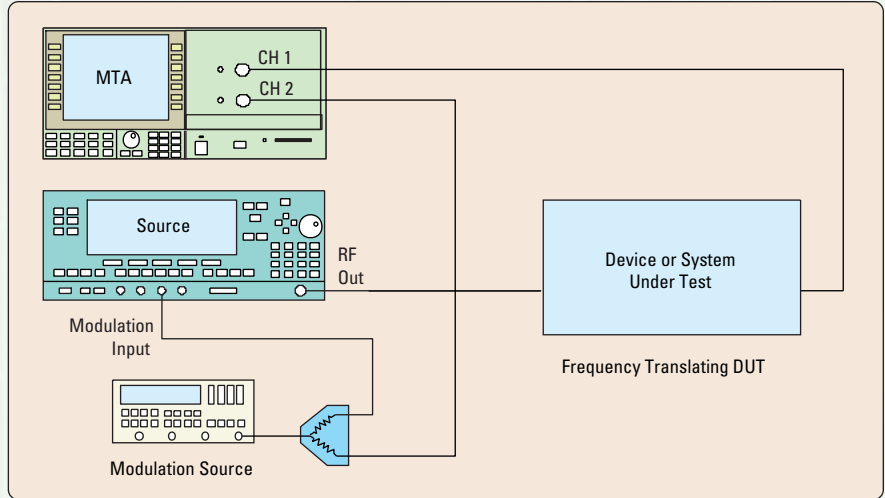



Figure 1. Measurement setup using an external modulation source

determine the delta phase at a particular frequency. The carrier must be stepped across the frequency band of interest for the complete group delay measurement. The modulation type can be AM, FM or PM.

A block diagram view of the measurement is shown in Figure 1. The modulated RF carrier is measured in channel 1 of the 71500A, while the baseband modulation signal is measured as a reference in channel 2.

Using an external-controlling computer, the source can be set to multiple frequencies and measured with the MTA to obtain both absolute and relative group delay as a function of frequency. This technique can measure delay through a mixer, a converter or an entire satellite ground station, even with the source and MTA in separate locations.

 Check item 2 on the business reply card to receive a product note on measuring group delay with Agilent's 71500A microwave transition analyzer, or download this note from our website at:

www.tm.agilent.com/tmo/Notes/English/5091-8634E.html



Low-power mixer design using the Advanced Design System

If you need comprehensive resource materials and tools for designing mixers and other circuits, you can use the Agilent EEsof Advanced Design System (ADS) and its complementary application notes. Here we describe one example of how the ADS is used in designing a low-power, single-transistor, active mixer. Other mixer examples are included in the ADS software.

Low-power mixer design

The design of this mixer is suited for portable applications in which cost and very low power consumption are the driving factors. The mixer is an upper-sideband down-converter with a 900 MHz RF and a 45 MHz IF. The simplified specifications supplied for this design call for the mixer to provide 10 dB conversion gain, operating from a 1-volt DC supply at 600 mA current.

The design uses the Motorola MMBR941 bipolar junction transistor (BJT). While the mixing properties of bipolar devices generally are not as good as those of field-effect transistors, the low operating voltage specified in this case precludes using FETs. In the design process, simulations are performed to properly characterize the DC performance of the device, which helps to establish the bias circuitry. After the mixer has been designed for DC operation, S-parameter simulation ensures proper RF performance.

Large-signal verification allows testing of such things as RF compression (P_{out}/P_{in} starts to fall off from its small-signal value), harmonic content, and conversion gain versus LO drive level. Another important step uses simulation to determine what impedances are seen for both the RF

and IF at each port. The finished input network will match the device base to 50 ohms at the RF and present a short circuit at the IF. Likewise, the output network will match the collector to 50 ohms at the IF, while presenting a short circuit to the RF. Since the device is not unilateral, the presence of a short circuit on one side of the device will affect the impedance seen at the other side for matching purposes.

Once the circuit has been determined, the ideal components can be converted to their nearest equivalent SMT parts. ADS layout is used to position the components and add connecting traces. A ground plane is added to the topside metallization to eliminate the need for vias, which reduces fabrication costs.

Mixer design application notes

Application notes are available that describe this and other mixer examples in detail.

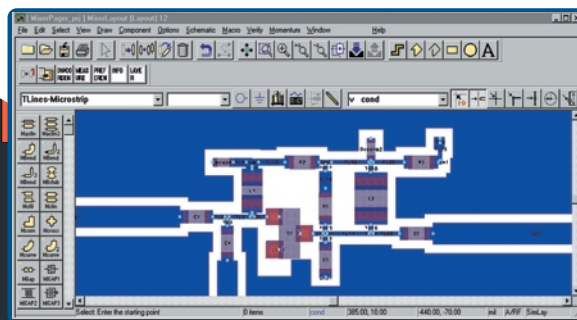
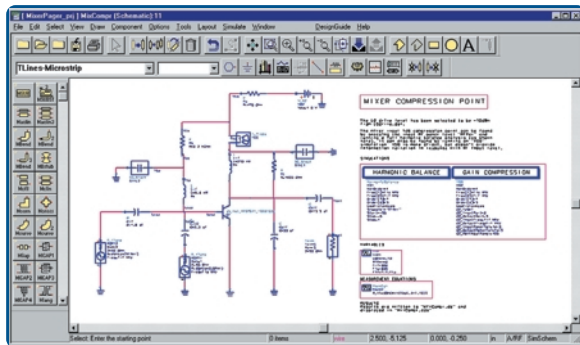

 Check item 3 on the business reply card to receive the application note *Low-Power Mixer Design Example using Agilent EEsof Advanced Design System.*

 Check item 4 on the business reply card to receive the application note *Mixer Simulation with Agilent EEsof Advanced Design System.*

You may also download these from our website at:

www.tm.agilent.com/tmo/hpeesof/apps/ads/index.htm

For more information visit the Advanced Design System web site at

www.agilent.com/find/eesof

Let RF experts train your team

Back-to-Basics Seminar on the road



Coming to a city near you, Agilent's Back-to-Basics Seminar 2000 introduces your team to common RF and microwave measurements and the instruments used to make them. For the upcoming schedule go to www.agilent.com/find/b2b. For presentation of the seminar at your site, contact your local Agilent sales office.

RF and microwave training by Besser Associates

Understanding the details of testing high frequency components can be a challenging task. Besser Associates of Mountain View, California, offers training classes in a broad range of RF and wireless topics. Classes are delivered year-round in four U.S. locations or by arrangement at your site. Self-paced courses are available on CD-ROM or via the Internet. Theory combined with hands-on practice and the latest tools and technology deliver the maximum training experience. Course topics and schedule are available on the Web:

www.bessercourse.com

DesignSeminar CDs deliver design oriented training

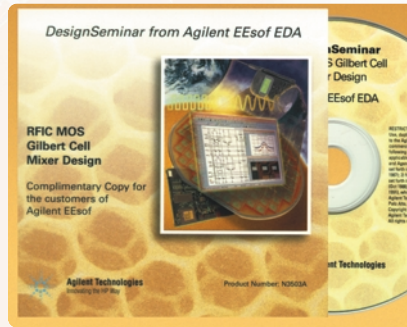

Fundamentals of Mixer Design and *RFIC MOS Gilbert Cell Mixer Design* are two titles in a series of computer-based training (CBT) *DesignSeminar* CDs. *DesignSeminars* are focused, application-oriented training modules developed and delivered by industry experts. They feature a combination of video and slide presentations to help a designer understand the operating principles of various types of circuit design. A designer can expect to gain an understanding of the theory of operation and how to specify performance such as gain, NF, P_{1dB} , TOI, and spur-free dynamic range. Project file examples that work with the Agilent EEsof Advanced Design System are provided on the CD to emphasize the concepts presented in the *DesignSeminars*. Dr. Stephen Long, professor of electrical and computer engineering at University of California Santa Barbara, conducts the two *DesignSeminars* that focus on mixers.

You can purchase *DesignSeminar* CDs on mixers and other topics directly from the Web:

www.tm.agilent.com/tmo/hpeesof/buy.html

Network analyzer selection guide now available



Agilent Technologies' new selection guide will help you select the best network analyzer for your measurement needs. This guide provides detailed comparisons of specifications and features, and includes all of Agilent's network analyzers, with transmission/reflection and S-parameter test sets that cover frequency ranges from 10 Hz to over 100 GHz.



Check item 5 on the business reply card for a copy of the network analyzer selection guide, or download a copy from our website:

www.agilent.com/find/nasg.



What's new from Agilent Technologies

Using an LCR meter to measure RF components



Agilent's new 4287A precision LCR meter and 16196 family of test fixtures provide fast, accurate, repeatable, and easy-to-perform measurements of RF passive components. Whether your production processes demand automated measurements at frequencies as high as 3 GHz or your quality department needs a repeatable measurement solution, the 4287A is built with speed and stability in mind. Point measurement speeds are as fast as 9 ms, and the noise floor is a tenth that of previous LCR meters. A direct current and voltage measurement technique (RF I-V) makes accurate measurement possible over a broad impedance range.

The 16196 test fixtures are designed to eliminate operator error. These new fixtures enable highly repeatable measurements since they have no adjustable parts. The applicable EIA chip case sizes are 0603, 0402, and 0201 for models 16196A, B, and C, respectively.



Check item 6 on the business reply card for more information on the Agilent 4287A and 16196 family, or go to

www.agilent.com/find/4287

More choices in network analysis

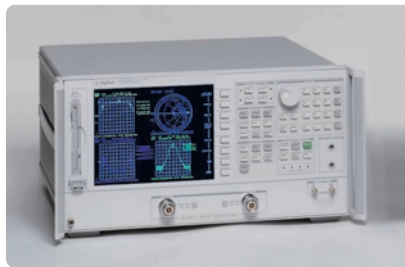

New versions of Agilent's 8753 and 8720 series vector network analyzers offer economical transmission/reflection test sets (ET models) as well as S-parameter test sets (ES models). The 8753ET/ES provide measurements from 30 kHz to 3 or 6 GHz, and the 8719ET/ES, 8720ET/ES, and 8722ET/ES from 50 MHz to 13.5, 20, or 40 GHz, respectively.

Features include enhanced response calibration for improved accuracy in transmission measurements without sacrificing measurement speed, ease-of-use and flexibility enhancements to the four-parameter display, and an improved user interface with new hardkeys for faster access to selected functions. The 8753ES also has a new, configurable test set (Option 014) that provides more flexible customization for specific applications.



Check item 7 on the business reply card for more information, or go to:

www.agilent.com/find/8753 or
www.agilent.com/find/8720

RF ECal modules for 7-16, 75-ohm type-N, and type-F connectors



Three new RF ECal modules provide electronic calibration in more connector types. Agilent's 85096A provides calibration in 75-ohm type-N environments and covers 30 kHz to 3 GHz. The 85098A module has the 7-16 connectors commonly used for base-station components and covers 30 kHz to 7.5 GHz. The 85099A offers type-F connectors for cable TV and broadband applications. This module covers the frequency range from 30 kHz to 3 GHz.



Check item 8 on the business reply card for more information, or go to:

www.agilent.com/find/ecal

Data Subject to Change
©2000 Agilent Technologies
Printed in U.S.A. 2/00
5968-8753E